

▲ радиатор

Stylos, отдельно стоящая версия 660↑ x 646↔ LP,
цвет: antique brass,
код продукта и конфигурации: WG4SF066064 LAN5LP

192 ЦВЕТА RAL
И СПЕЦИАЛЬНАЯ
ПАЛИТРА ЦВЕТОВ,
ПРЕДНАЗНАЧЕННАЯ ДЛЯ
ЧУГУННЫХ РАДИАТОРОВ.



STYLOS 





ДОСТУПНЫЕ РАЗМЕРЫ

НАСТЕННАЯ ВЕРСИЯ

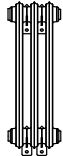
600 x 60
↓ ←

600 x 216

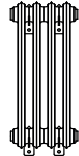

600 x 277

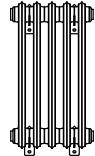

600 x 339

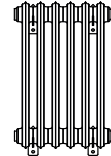

600 x 400

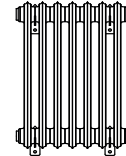

600 x 462

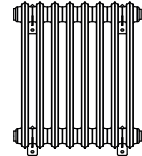

600 x 523

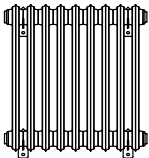
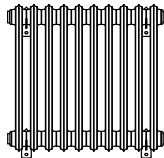
600 x 589
↓ ←

600 x 646

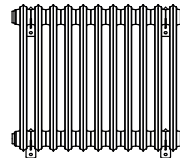

600 x 708

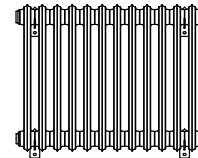

600 x 769

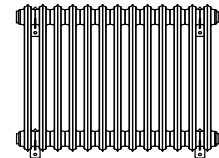

600 x 831

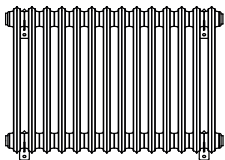
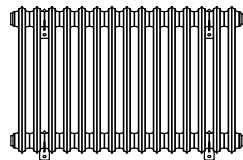
600 x 892
↓ ←

600 x 954

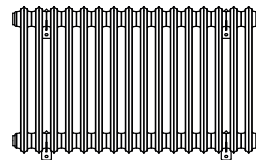

600 x 1015

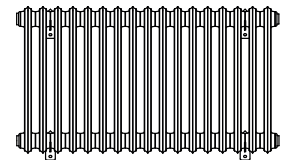

600 x 1077

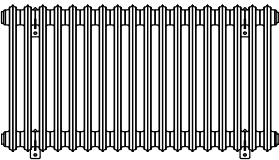
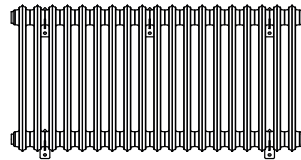
600 x 1138
↓ ←

600 x 1200

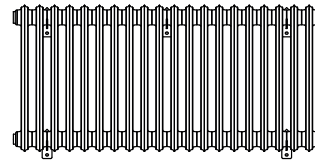

600 x 1261

ДОСТУПНЫЕ РАЗМЕРЫ

НАСТЕННАЯ ВЕРСИЯ



700 x 60
 ↓ ↔

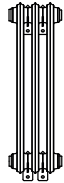

700 x 216

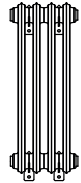

700 x 277



700 x 339

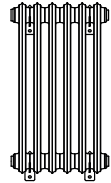

700 x 400

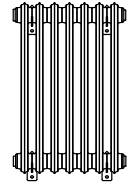

700 x 462

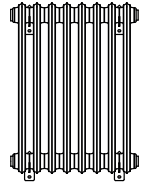

700 x 523

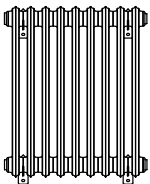

700 x 589
 ↓ ↔

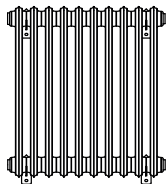

700 x 646

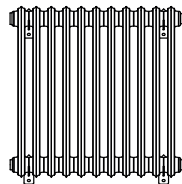

700 x 708

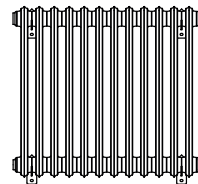

700 x 769

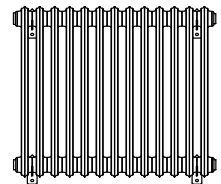

700 x 831

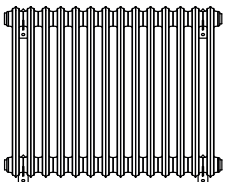

700 x 892
 ↓ ↔

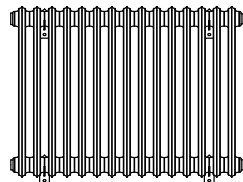

700 x 954

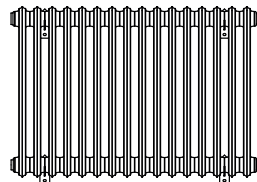

700 x 1015

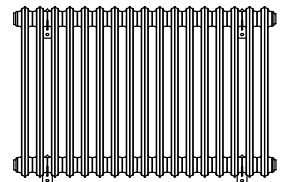

700 x 1077

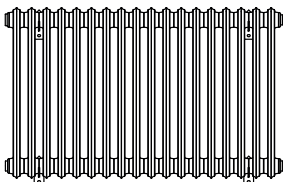

700 x 1138
 ↓ ↔

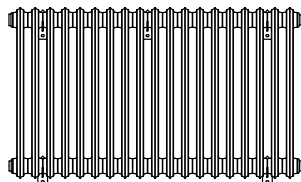

700 x 1200

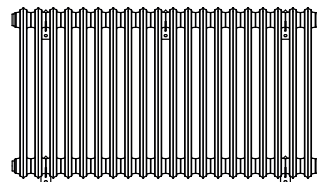

700 x 1261

ДОСТУПНЫЕ РАЗМЕРЫ

ОТДЕЛЬНО СТОЯЩАЯ ВЕРСИЯ

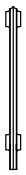

660 x 60
 ↓ ↔

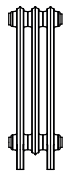

660 x 216



660 x 277

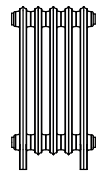

660 x 339

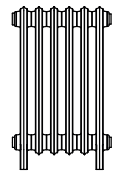

660 x 400

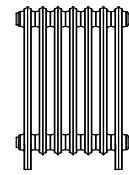

660 x 462

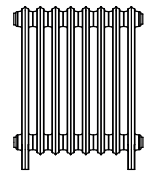

660 x 523

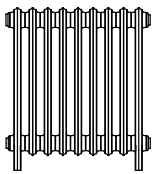

660 x 585
 ↓ ↔

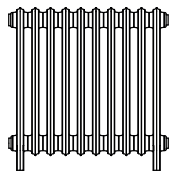

660 x 646

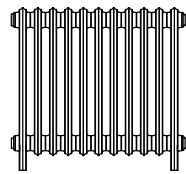

660 x 708

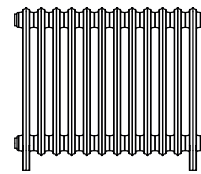

660 x 769

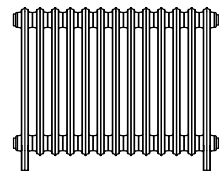

660 x 831

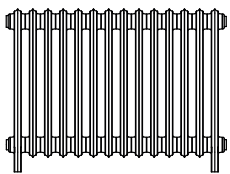

660 x 892
 ↓ ↔

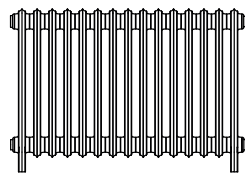

660 x 954

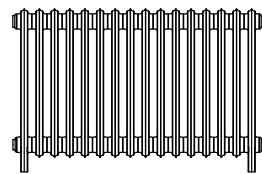

660 x 1015

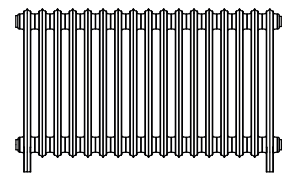

660 x 1077

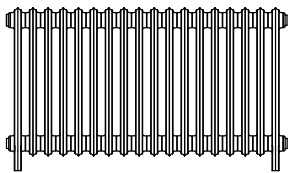

660 x 1138
 ↓ ↔

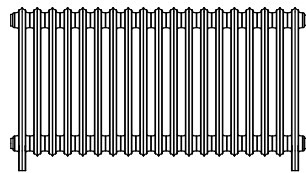

660 x 1200

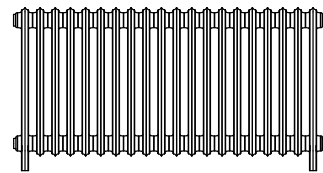

660 x 1261

ДОСТУПНЫЕ РАЗМЕРЫ

ОТДЕЛЬНО СТОЯЩАЯ ВЕРСИЯ



760 x 60
 ↓ ↔



760 x 216

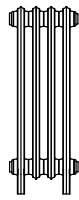

760 x 277



760 x 339



760 x 400

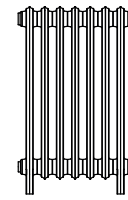

760 x 462

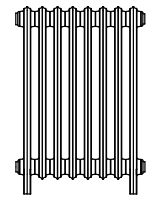

760 x 523

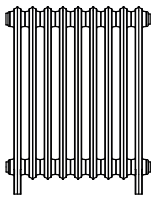

760 x 585
 ↓ ↔

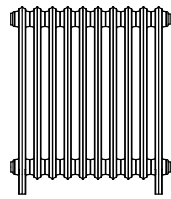

760 x 646

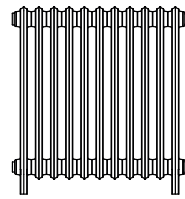

760 x 708

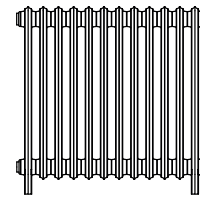

760 x 769

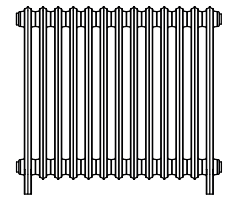

760 x 831

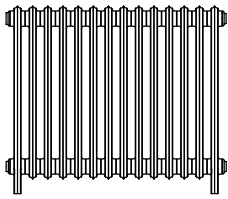

760 x 892
 ↓ ↔

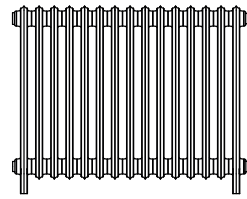

760 x 954

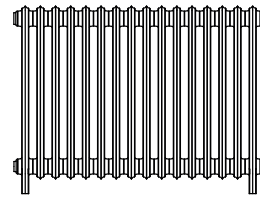

760 x 1015

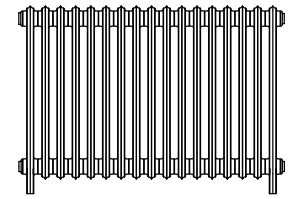

760 x 1077

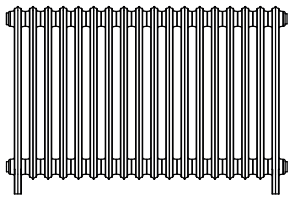

760 x 1138
 ↓ ↔

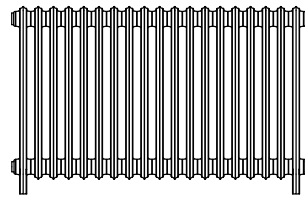

760 x 1200

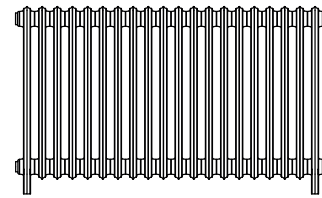

760 x 1261

ВЫХОД – НАСТЕННАЯ ВЕРСИЯ

ВОДЯНОЙ РАДИАТОР ЦЕНТРАЛЬНОГО ОТОПЛЕНИЯ

Связи:





Количество секций	Высота A ↓ [mm]	Ширина B ↔ [mm]	Мощность нагрева		Код продукта ... Код конфигурации, информационная страница 13
			75/65/20°C [W]	55/45/20°C [W]	
3	600	216	256	135	WG4SB060021...
4	600	277	341	180	WG4SB060027...
5	600	339	427	225	WG4SB060033...
6	600	400	512	270	WG4SB060040...
7	600	462	597	315	WG4SB060046...
8	600	523	682	360	WG4SB060052...
9	600	585	768	405	WG4SB060058...
10	600	646	853	450	WG4SB060064...
11	600	708	938	495	WG4SB060070...
12	600	769	1024	540	WG4SB060076...
13	600	831	1109	585	WG4SB060083...
14	600	892	1194	630	WG4SB060089...
15	600	954	1280	675	WG4SB060095...
16	600	1015	1365	720	WG4SB060101...
17	600	1077	1450	765	WG4SB060107...
18	600	1138	1535	810	WG4SB060113...
19	600	1200	1621	855	WG4SB060120...
20	600	1261	1706	900	WG4SB060126...
3	700	216	307	159	WG4SB070021...
4	700	277	410	212	WG4SB070027...
5	700	339	512	265	WG4SB070033...
6	700	400	614	317	WG4SB070040...
7	700	462	717	370	WG4SB070046...
8	700	523	819	423	WG4SB070052...
9	700	585	922	476	WG4SB070058...
10	700	646	1024	529	WG4SB070064...
11	700	708	1126	582	WG4SB070070...
12	700	769	1229	635	WG4SB070076...
13	700	831	1331	688	WG4SB070083...
14	700	892	1434	741	WG4SB070089...
15	700	954	1536	794	WG4SB070095...
16	700	1015	1638	846	WG4SB070101...
17	700	1077	1741	899	WG4SB070107...
18	700	1138	1843	952	WG4SB070113...
19	700	1200	1946	1005	WG4SB070120...
20	700	1261	2048	1058	WG4SB070126...

ТЕХНИЧЕСКИЕ ДЕТАЛИ

Рабочее давление: 1000 кПа

Максимальная рабочая температура: 95°C

Количество секций	Высота A ↕ [mm]	Ширина B ↔ [mm]	C [mm]	D [mm]	D' [mm]	Емкость  [dm³]	Масса  [kg]
Настенная версия							
3	600	216	500	–	77	2,43	17,26
4	600	277	500	123	77	3,24	22,68
5	600	339	500	185	77	4,05	28,15
6	600	400	500	246	77	4,86	33,57
7	600	462	500	308	77	5,67	39,04
8	600	523	500	369	77	6,48	44,46
9	600	585	500	431	77	7,29	49,93
10	600	646	500	492	77	8,10	55,35
11	600	708	500	554	77	8,91	60,82
12	600	769	500	615	77	9,72	66,24
13	600	831	500	677	77	10,53	71,71
14	600	892	500	738	77	11,34	77,13
15	600	954	500	676	139	12,15	82,60
16	600	1015	500	737	139	12,96	88,02
17	600	1077	500	799	139	13,77	93,49
18	600	1138	500	860	139	14,58	98,91
19	600	1200	500	922	139	15,39	104,38
20	600	1261	500	983	139	16,20	109,80
3	700	216	600	–	77	3,00	20,53
4	700	277	600	123	77	4,00	27,04
5	700	339	600	185	77	5,00	33,60
6	700	400	600	246	77	6,00	40,11
7	700	462	600	308	77	7,00	46,67
8	700	523	600	369	77	8,00	53,18
9	700	585	600	431	77	9,00	59,74
10	700	646	600	492	77	10,00	66,25
11	700	708	600	554	77	11,00	72,82
12	700	769	600	615	77	12,00	79,32
13	700	831	600	677	77	13,00	85,88
14	700	892	600	738	77	14,00	92,39
15	700	954	600	676	139	15,00	98,95
16	700	1015	600	737	139	16,00	105,46
17	700	1077	600	799	139	17,00	112,02
18	700	1138	600	860	139	18,00	118,53
19	700	1200	600	922	139	19,00	125,09
20	700	1261	600	983	139	20,00	131,60

ВЫХОД – НАСТЕННАЯ ВЕРСИЯ

ВОДЯНОЙ РАДИАТОР ЦЕНТРАЛЬНОГО ОТОПЛЕНИЯ

Связи:





Количество секций	Высота A ↓ [mm]	Ширина B ↔ [mm]	Мощность нагрева		Код продукта ... Код конфигурации, информационная страница 13
			75/65/20°C [W]	55/45/20°C [W]	
3	660	216	256	135	WG4SF066021...
4	660	277	341	180	WG4SF066027...
5	660	339	427	225	WG4SF066033...
6	660	400	512	270	WG4SF066040...
7	660	462	597	315	WG4SF066046...
8	660	523	682	360	WG4SF066052...
9	660	585	768	405	WG4SF066058...
10	660	646	853	450	WG4SF066064...
11	660	708	838	495	WG4SF066070...
12	660	769	1024	540	WG4SF066076...
13	660	831	1109	585	WG4SF066083...
14	660	892	1194	630	WG4SF066089...
15	660	954	1280	675	WG4SF066095...
16	660	1015	1365	720	WG4SF066101...
17	660	1077	1450	765	WG4SF066107...
18	660	1138	1535	810	WG4SF066113...
19	660	1200	1621	855	WG4SF066120...
20	660	1261	1706	900	WG4SF066126...
3	760	216	307	159	WG4SF076021...
4	760	277	410	212	WG4SF076027...
5	760	339	512	265	WG4SF076033...
6	760	400	614	317	WG4SF076040...
7	760	462	717	370	WG4SF076046...
8	760	523	819	423	WG4SF076052...
9	760	585	922	476	WG4SF076058...
10	760	646	1024	529	WG4SF076064...
11	760	708	1126	582	WG4SF076070...
12	760	769	1229	635	WG4SF076076...
13	760	831	1331	688	WG4SF076083...
14	760	892	1434	741	WG4SF076089...
15	760	954	1536	794	WG4SF076095...
16	760	1015	1638	846	WG4SF076101...
17	760	1077	1741	899	WG4SF076107...
18	760	1138	1843	952	WG4SF076113...
19	760	1200	1946	1005	WG4SF076120...
20	760	1261	2048	1058	WG4SF076126...

ТЕХНИЧЕСКИЕ ДЕТАЛИ

Рабочее давление: 1000 кПа

Максимальная рабочая температура: 95°C

Количество секций	Высота A ↕ [mm]	Ширина B ↔ [mm]	C [mm]	D [mm]	D1 [mm]	Емкость  [dm³]	Масса  [kg]
Отдельно стоящая версия							
3	660	216	500	–	–	2,43	18,14
4	660	277	500	–	–	3,24	23,56
5	660	339	500	–	–	4,05	29,03
6	660	400	500	–	–	4,86	34,45
7	660	462	500	–	–	5,67	39,92
8	660	523	500	–	–	6,48	45,34
9	660	585	500	–	–	7,29	50,81
10	660	646	500	–	–	8,10	56,23
11	660	708	500	–	–	8,91	61,70
12	660	769	500	–	–	9,72	67,12
13	660	831	500	–	–	10,53	72,59
14	660	892	500	–	–	11,34	78,01
15	660	954	500	–	–	12,15	83,48
16	660	1015	500	–	–	12,96	88,90
17	660	1077	500	–	–	13,77	94,37
18	660	1138	500	–	–	14,58	99,79
19	660	1200	500	–	–	15,39	105,26
20	660	1261	500	–	–	16,20	110,68
3	760	216	600	–	–	3,00	21,49
4	760	277	600	–	–	4,00	28,00
5	760	339	600	–	–	5,00	34,56
6	760	400	600	–	–	6,00	41,07
7	760	462	600	–	–	7,00	47,63
8	760	523	600	–	–	8,00	54,14
9	760	585	600	–	–	9,00	60,70
10	760	646	600	–	–	10,00	67,21
11	760	708	600	–	–	11,00	73,77
12	760	769	600	–	–	12,00	80,28
13	760	831	600	–	–	13,00	86,84
14	760	892	600	–	–	14,00	93,35
15	760	954	600	–	–	15,00	99,91
16	760	1015	600	–	–	16,00	106,42
17	760	1077	600	–	–	17,00	112,98
18	760	1138	600	–	–	18,00	119,49
19	760	1200	600	–	–	19,00	126,05
20	760	1261	600	–	–	20,00	132,56

ТЕХНИЧЕСКИЙ РИСУНОК

НАСТЕННАЯ ВЕРСИЯ

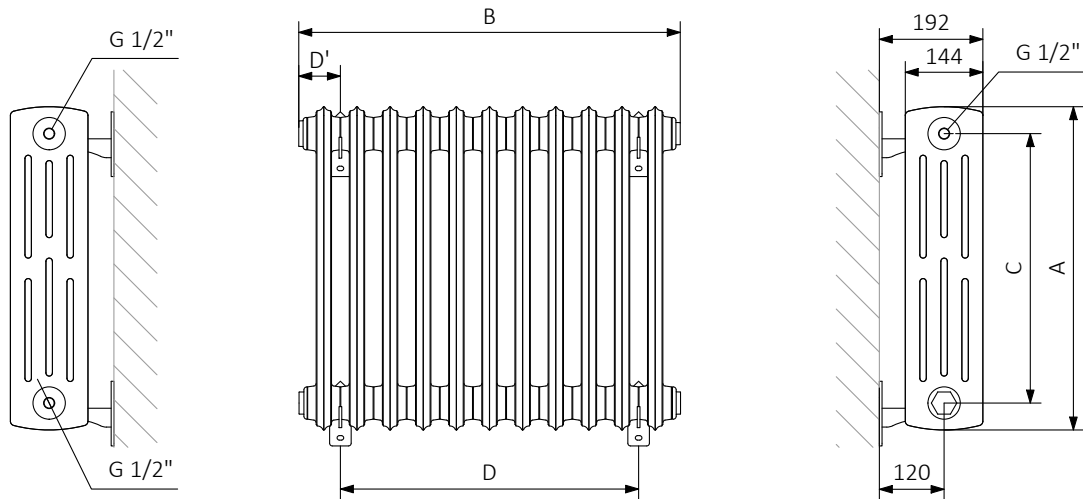

ОТДЕЛЬНО СТОЯЩАЯ ВЕРСИЯ

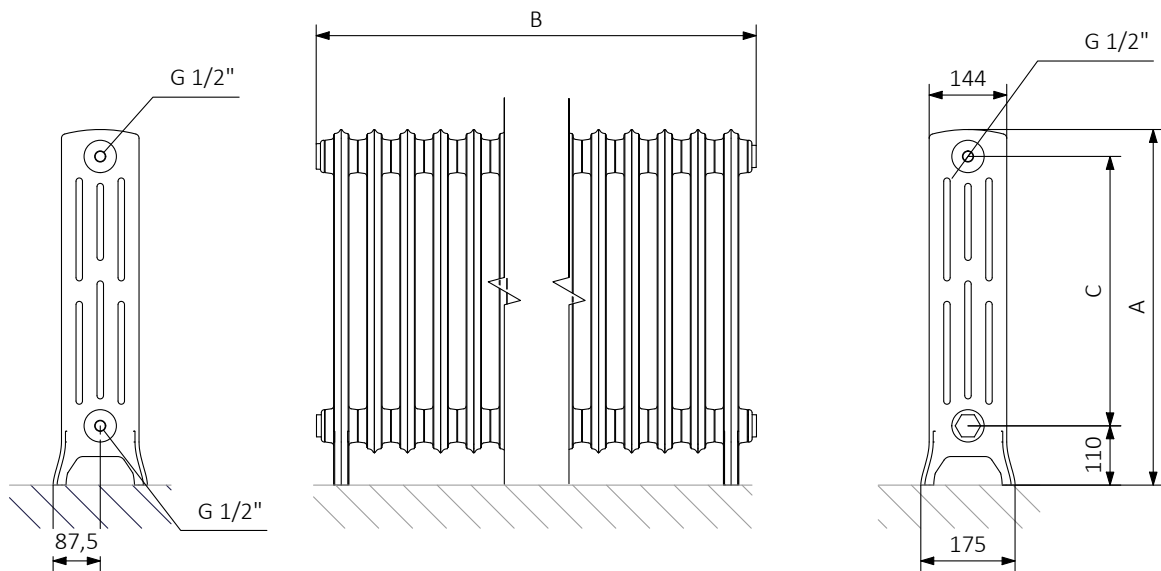

A – Высота B – Ширина C – расстояние соединения D – расстояние нижних креплений
 D' - расстояние более высоких креплений

СТРУКТУРА КОДА КОНФИГУРАЦИИ – ВОДЯНОЙ РАДИАТОР ЦЕНТРАЛЬНОГО ОТОПЛЕНИЯ (ГРУППА ПРОДУКТОВ "WG")

Таблицы технических паспортов продуктов содержат коды продуктов, которые предоставляют основную информацию о продуктах, а также частично заполненный код конфигурации, дополняющий информацию подробными характеристиками продукта. Для оформления заказа коды продуктов необходимо дополнить полным кодом конфигурации. Код конфигурации следует размещать после кода продукта. Ниже представлена структура кода продукта и кода конфигурации.

СТРУКТУРА КОДА:

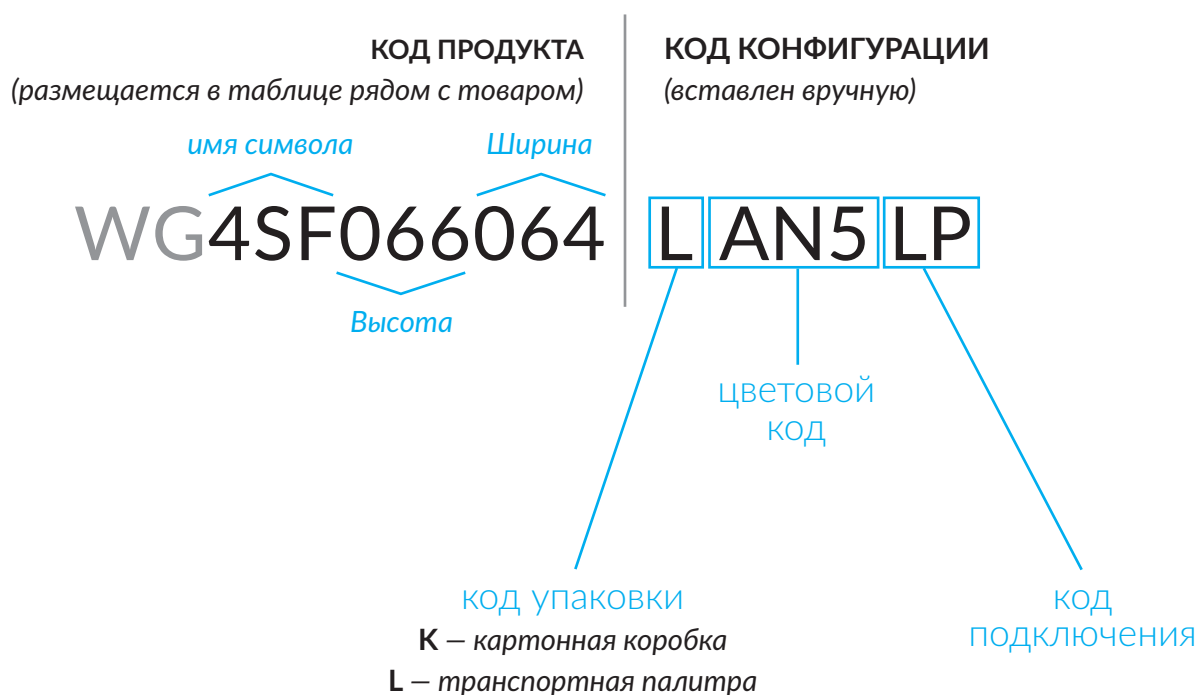

ПАЛИТРА ОТДЕЛКИ ЧУГУННЫХ РАДИАТОРОВ

Помимо палитры из 192 стандартных цветов RAL (мокрая краска), мы предлагаем палитру специальных цветов и ряд декоративных покрытий. По специальному желанию клиента мы также изготавливаем радиаторы и аксессуары в индивидуально подобранной отделке.

SPECIAL COLOURS PALETTE

ГРУППА 1



WHITE SOFT

WS3

FROST

FR3

METALLIC BROWN

AB3

AUTUMN

AU3

EVENING GARDEN

EG3

SHADOW GOLD

SG3

GRAFF

GR3

FLAT BLACK

FB3

RAW METAL

ZE3

METAL ALIVE

ZE1

PALETA RAL

ГРУППА 2



ANTIQUÉ COPPER

AC5

ANTIQUÉ BRASS

AN5

FULL BURNISH

FB2

BOTTLE GREEN

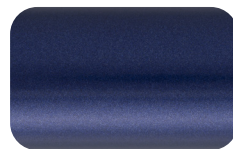
BGR

MIDNIGHT

MDN

SHADED BURNISH

FB4

RED WINE

RWE

ГРУППА 3



ORNAMENT GOLD*

GR7

ORNAMENT SILVER*

GR9

ORNAMENT COPPER*

GR8

GALVANIC COPPER

GC5

POLISHED METAL

ZE2

* выставленный орнамент можно выполнить поверх любого цвета из палитры группы 1

ПАЛИТРА ЦВЕТОВ RAL

100 – RAL 1000	302 – RAL 3002	511 – RAL 5011	627 – RAL 6027	745 – RAL 7045
101 – RAL 1001	303 – RAL 3003	512 – RAL 5012	628 – RAL 6028	746 – RAL 7046
102 – RAL 1002	304 – RAL 3004	513 – RAL 5013	629 – RAL 6029	747 – RAL 7047
103 – RAL 1003	305 – RAL 3005	514 – RAL 5014	632 – RAL 6032	800 – RAL 8000
104 – RAL 1004	307 – RAL 3007	515 – RAL 5015	633 – RAL 6033	801 – RAL 8001
105 – RAL 1005	309 – RAL 3009	517 – RAL 5017	634 – RAL 6034	802 – RAL 8002
106 – RAL 1006	311 – RAL 3011	518 – RAL 5018	700 – RAL 7000	803 – RAL 8003
107 – RAL 1007	312 – RAL 3012	519 – RAL 5019	701 – RAL 7001	804 – RAL 8004
111 – RAL 1011	313 – RAL 3013	520 – RAL 5020	702 – RAL 7002	807 – RAL 8007
112 – RAL 1012	314 – RAL 3014	521 – RAL 5021	703 – RAL 7003	808 – RAL 8008
113 – RAL 1003	315 – RAL 3015	522 – RAL 5022	704 – RAL 7004	811 – RAL 8011
114 – RAL 1014	316 – RAL 3016	523 – RAL 5023	705 – RAL 7005	812 – RAL 8012
115 – RAL 1015	317 – RAL 3017	524 – RAL 5024	706 – RAL 7006	814 – RAL 8014
116 – RAL 1016	318 – RAL 3018	600 – RAL 6000	708 – RAL 7008	815 – RAL 8015
117 – RAL 1017	320 – RAL 3020	601 – RAL 6004	709 – RAL 7009	816 – RAL 8016
118 – RAL 1018	322 – RAL 3022	602 – RAL 6002	710 – RAL 7010	817 – RAL 8017
119 – RAL 1019	327 – RAL 3027	603 – RAL 6003	711 – RAL 7011	819 – RAL 8019
120 – RAL 1020	328 – RAL 3028	604 – RAL 6004	712 – RAL 7012	822 – RAL 8022
121 – RAL 1021	331 – RAL 3031	605 – RAL 6005	713 – RAL 7013	823 – RAL 8023
123 – RAL 1023	401 – RAL 4001	606 – RAL 6006	715 – RAL 7015	824 – RAL 8024
124 – RAL 1024	402 – RAL 4002	607 – RAL 6007	716 – RAL 7016	825 – RAL 8025
127 – RAL 1027	403 – RAL 4003	608 – RAL 6008	721 – RAL 7021	828 – RAL 8028
128 – RAL 1028	404 – RAL 4004	609 – RAL 6009	722 – RAL 7022	901 – RAL 9001
132 – RAL 1032	405 – RAL 4005	610 – RAL 6010	723 – RAL 7023	902 – RAL 9002
133 – RAL 1033	406 – RAL 4006	611 – RAL 6011	724 – RAL 7024	903 – RAL 9003
134 – RAL 1034	407 – RAL 4007	612 – RAL 6012	726 – RAL 7026	904 – RAL 9004
137 – RAL 1037	408 – RAL 4008	613 – RAL 6013	730 – RAL 7030	9M5 – RAL 9005
200 – RAL 2000	409 – RAL 4009	614 – RAL 6014	732 – RAL 7032	906 – RAL 9006
201 – RAL 2001	410 – RAL 4010	615 – RAL 6015	733 – RAL 7033	907 – RAL 9007
202 – RAL 2002	500 – RAL 5000	616 – RAL 6016	734 – RAL 7034	910 – RAL 9010
203 – RAL 2003	501 – RAL 5001	617 – RAL 6017	735 – RAL 7035	911 – RAL 9011
204 – RAL 2004	502 – RAL 5002	618 – RAL 6018	736 – RAL 7036	916 – RAL 9016
208 – RAL 2008	503 – RAL 5003	619 – RAL 6019	737 – RAL 7037	917 – RAL 9017
209 – RAL 2009	504 – RAL 5004	620 – RAL 6020	738 – RAL 7038	918 – RAL 9018
210 – RAL 2010	505 – RAL 5005	621 – RAL 6021	739 – RAL 7039	
211 – RAL 2011	507 – RAL 5007	622 – RAL 6022	740 – RAL 7040	
212 – RAL 2012	508 – RAL 5008	624 – RAL 6024	742 – RAL 7042	
300 – RAL 3000	509 – RAL 5009	625 – RAL 6025	743 – RAL 7043	
301 – RAL 3001	510 – RAL 5010	626 – RAL 6026	744 – RAL 7044	